

MV without reflector

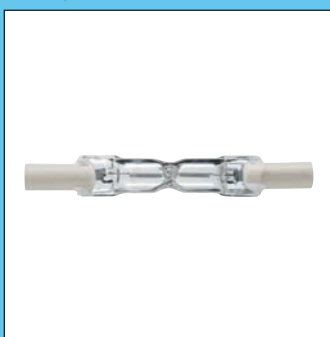

DEComp R7s/10



DEComp R7s/18

Dimensions in mm

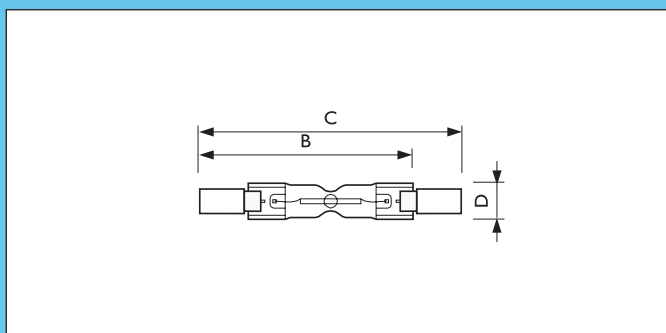

Plusline Pro Compact

Product Description

- Mains-voltage linear lamp with a coiled-coil filament, giving white halogen light

Product Feature

- Double-ended high-efficacy lamps
- Clear tubular quartz bulb
- Reinforced filament supports for maximum safety and shock resistance resulting in longer lifetime
- Two arc-preventing fuses for greater safety
- Excellent color rendering
- Constant light output during life

Product Benefit

- 20% more light than ordinary double-ended
- Long lifetime

Application

- Typically used in shop lighting applications
- Indoor: homes, offices, shops and museums
- Outdoor: billboards, car parks, security lighting and construction sites

Luminaires

- Must be used in luminaires with a front cover glass

Product ID	Insertion length	Overall length	Diameter
	B nom.	C max.	D max.
150W	74.9	78.3	15

Preferred selection

Product ID	Rated Lamp Wattage [W]	Voltage [V]	Beam angle	Cap Base	Luminous Intensity [cd]	Life to 50% Failures [hrs]
PAR38 HalogenA	75W	230V	30D	E27	1870	2000
PAR38 HalogenA	100W	230V	30D	E27	2550	2000

Photometric diagrams

PAR38 HalogenA 75W E27 230V 30D

Light distribution curves

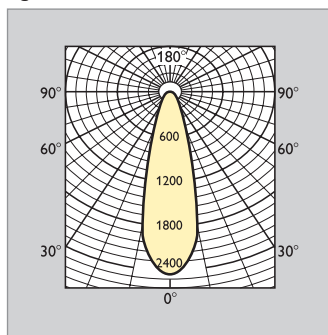

Beam diagram

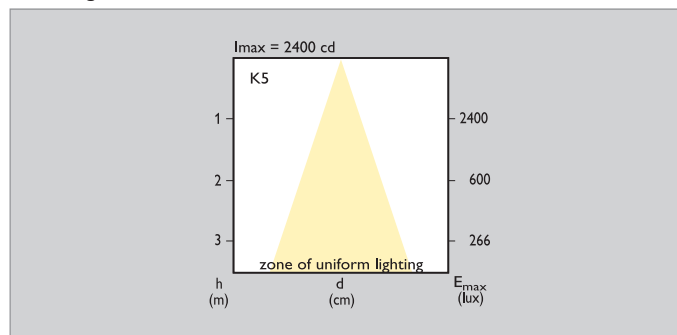

Accent diagram

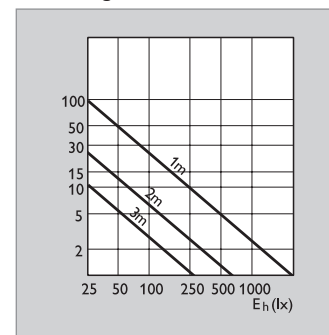

PAR38 HalogenA 100W E27 230V 30D

Light distribution curves

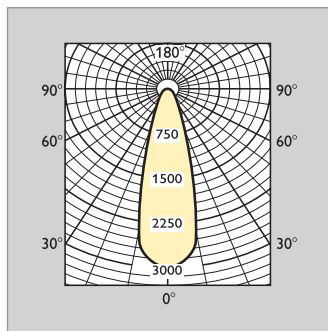

Beam diagram

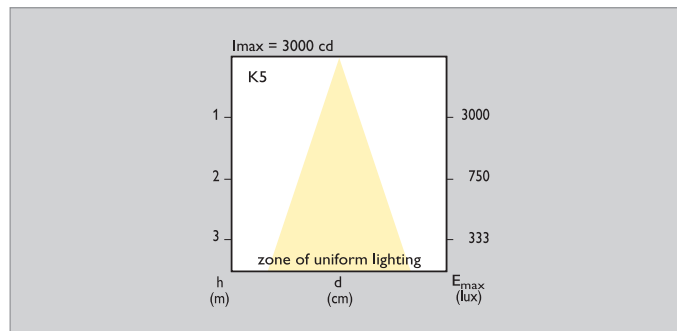

Accent diagram

